

BSWA 308 is a low cost Class 1 integrating sound level meter. It complies with the IEC61672 standards. The instrument features an industrially designed housing and offers a high level of comfort and style. The 1/2" measurement microphone (MP231 with MA231T ICCP preamplifier) is equipped with a TNC connector and can be operated or detached from the unit via microphone extension cable.

The BSWA308 has a dynamic range of 102 dB and always measure noise from 29 dBA to 131 dBA in single range. It can measure three parameters simultaneously with the A, C, and Z frequency weightings and with F, S, and I time weightings. In addition, the equivalent continuous sound pressure level, maximum and minimum values are calculated. The integration time for integral sound quantities can be set.

The BSWA308 is ideal sound level sound for general purposes of noise measurements where the Class 1 accuracy is required.



SPECIFICATIONS

Sound Level Meter BSWA308	
Standard	IEC 61672 Class I JJG Class I
Level Meter	SPL, LEQ, PEAK, MAX, MIN, Simultaneous measuring three profiles with independent sets of filters and detector time constants
Weighting Filters	A, C, Linear
RMS Detector	Fast, Slow, Impulse
Electrical Noise	21 dBA
Measurement Range	29 dBA~131 dBA
Frequency Range	20 Hz~20k Hz
Dynamic Range	102 dB
Input	ICCP type, TNC connector
Display	160 x 160 LCD With backlighting
Power supply	4 AA batteries
Operating Temperature	-10°C to 50°C
Humidity	Up to 90%
Size	300x70x36 mm
Weight	About 620 g



BSWA 308

Sound Level Meter

User Manual

No.BSWA-III-C021-03-0115

Version: V1.00



IEC61672
Class 1

BSWA 308 Sound Level Meter User Manual

©BSWA Technology Co., Ltd

©All rights reserved.

Product features and specifications are subject to change without notice.

Sep. 2010

REVISION HISTORY

Version	Date	Summary of Changes	Authors
1.00	Sep. 17 2010	Original version	Zhao Dawei Qiao Jie

THIS MANUAL CONTAINS PROPRIETARY INFORMATION THAT SHALL NOT BE USED FOR ANY OTHER PURPOSE THAN THAT FOR WHICH IT HAS BEEN RELEASED. THE INFORMATION CONTAINED HEREIN SHALL NOT BE REPRODUCED OR DISCLOSED TO THIRD PARTIES WITHOUT THE PRIOR WRITTEN CONSENT OF BSWA.

Appearance



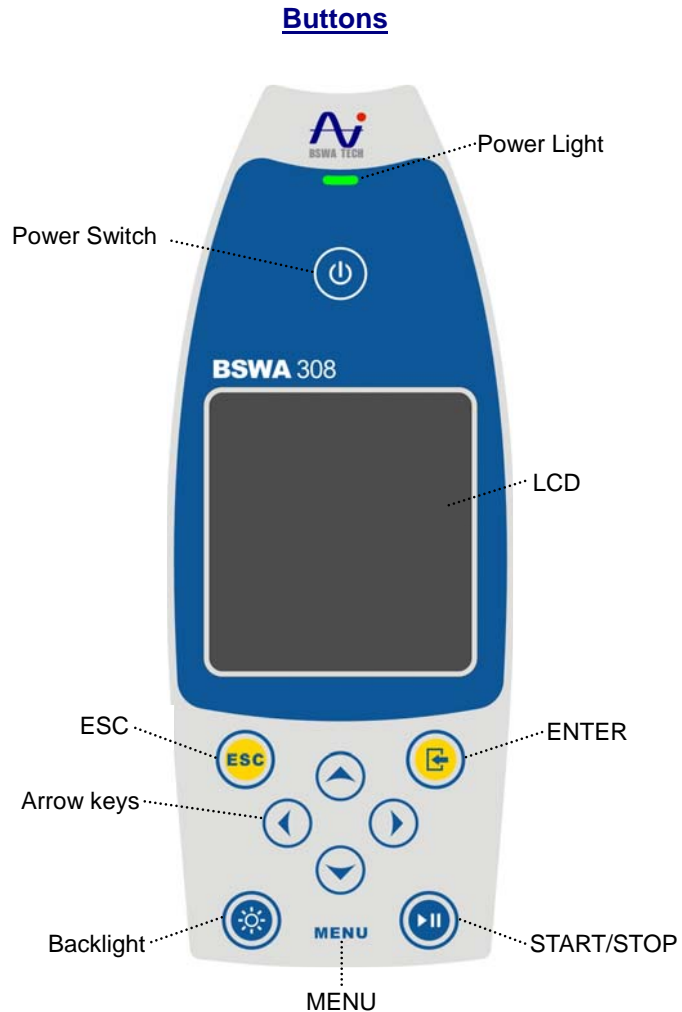

1. Introduction

1.1 General Description

The **BSWA 308** is a digital sound level meter that complies with the IEC61672 Class 1. This instrument is the basic model of **BSWA 300** series. The use of high precision 24Bits AD converter makes the instrument to be a ideal choose for performing many kinds of measurement tasks, for example in environmental noise, vehicle noise and industrial application. A main interface can display most useful information of the instrument states and basic noise result. In addition, there is a three profiles interface display independently result that measured in parallel. All profiles can be defined different filters (A,C,Z) and detector time constants (Impulse, Fast and Slow).

1.2 Applications:

- Basic noise measurement
- Environmental noise assessment
- Product quality check
- Noise reduction

1.3 Features:

- Conforms to IEC61672-1 Class 1, IEC60531 Type 1, GB/T3785-1985 Class 1, GB/T17181-1997 Class 1
- 100dB dynamic range
- Three profiles display

1.4 Specification

Sound Level Meter BSWA 308	
Standard	IEC 61672 Class 1, IEC 60531 Class 1 GB/T 3785 Class 1, GB/T 17181 Class 1
Level Meter	SPL, LEQ, PEAK, MAX, MIN
Weighting Filter	A, C, Linear
RMS Detector	Fast, Slow, Impulse
Electrical Noise	21 dBA
Measurement Range	29-131 BA
Frequency Range	20-20kHz
Dynamic Range	102 dBA
Input	ICCP, TNC connector
Display	160x160 LCD, with backlight
Power supply	1.5V Alkaline batteries (LR6/AA/AM3) x 4
Operation Temperature	-10°C ~ 50°C (14°F ~ 122°F)
Humidity	Up to 90%RH (non-condensing)
Size	300 x 70 x36 mm
Weight	About 620g, including batteries

1.5 Contents in the case

MPA231 Microphone	[]	BSWA 308	[]
CA111 Calibrator	[]	AD002 Adapter	[]
Wind Screen	[]	Alkaline AA Battery	x[]
Power Adapter	[]	User manual	[]

2. Battery Change

Turn the button to the left side to unlock the battery compartment cover. Then lift the cover to open it.

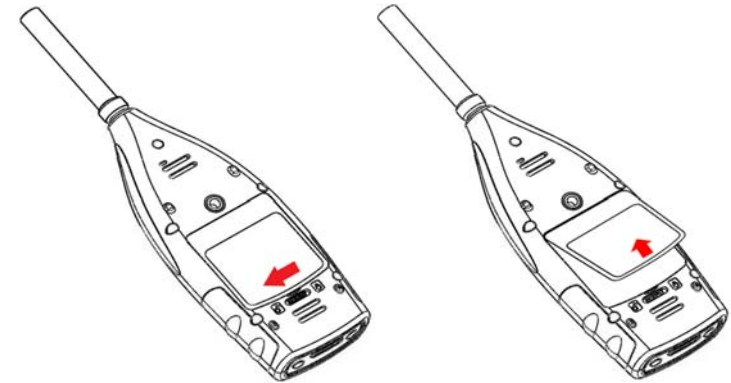

The **BSWA 308** use four Alkaline battery (LR6/AA/AM3), paying attention to the +/- marking in the battery compartment. Do not mix used and new batteries. Close and lock the battery compartment after change the battery.

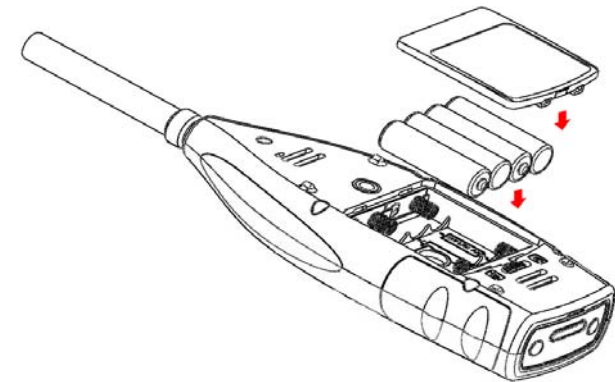

3. Microphone Mount

Insert the microphone to the TNC connector of the **BSWA 308**.

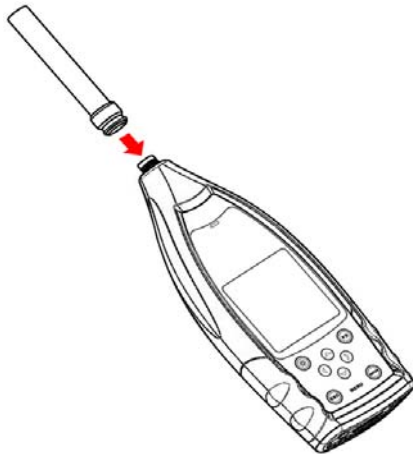

Rotate the microphone to fix it to the **BSWA 308**.

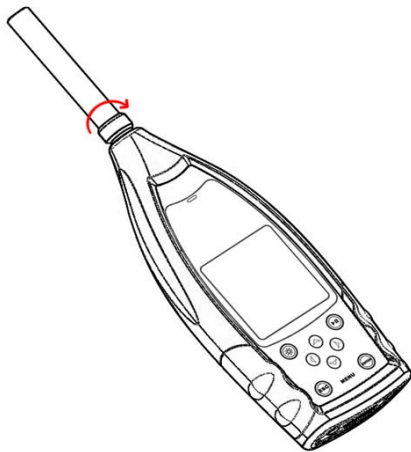

4. Operation and the Setting of the Menu

The main interface of **BSWA 308** displays the first result of the 3 profile.

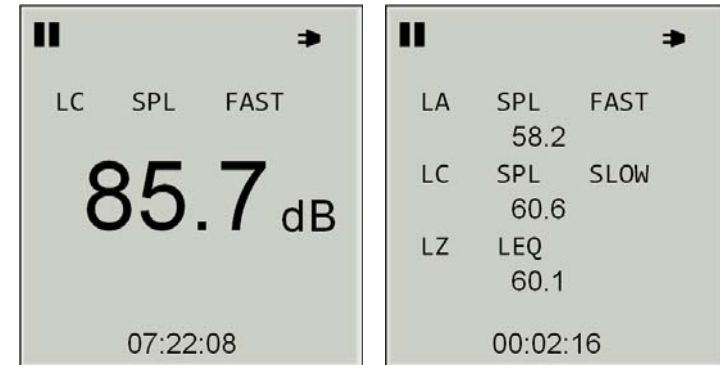

Press <MENU> to enter the main menu.

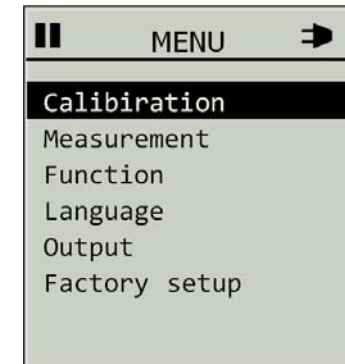

4.1 Calibration

In order to maintain the high accuracy, The Sound Level meter should be calibrated before each use, with an external sound level meter calibrator. If this is done, it is reasonable to assume that the calibration during the

measurement was correct.

Select the Calibration in the main menu, press <ENTER> to enter the Calibration option.

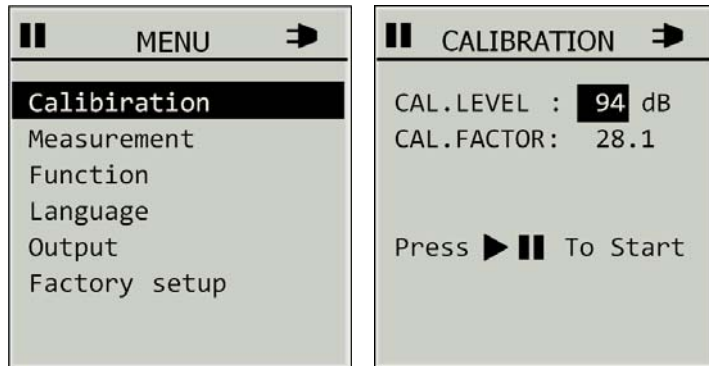

The **BSWA 308** includes three calibration levels: **94dB**, **114dB** and **124dB**. Press <←> and <→> to select the desire value. Then follow the notice press <START/STOP> to get the calibration factor. When display screen displays the notice: **Done**, press <ENTER> to save the new calibration factor as the current calibration factor and return the main menu automatic, press <ESC> to return the main menu and the new calibration factor will be lost.

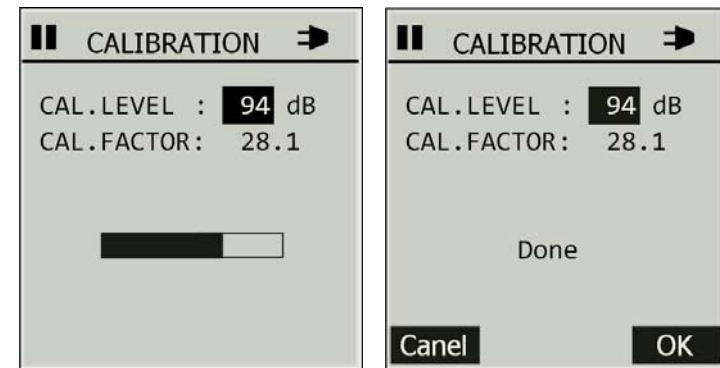

The **Factory setup** set the calibration factor zero as default.

4.2 Measurement

The **Measurement** option contains three profile measure setup (**SET1**, **SET2**, **SET3**), normal setup (**MEAS. Setup**), and the **BSWA 308**'s measure range (**MEAS. Range**).

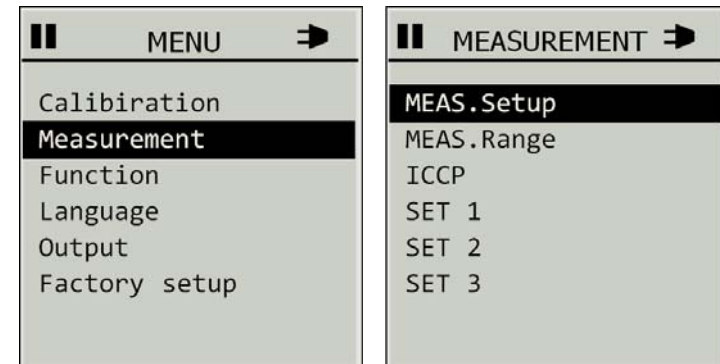

Press <ENTER> on the highlighted (displayed inversely) Measurement text to enter the Measurement option.

4.2.1 MEAS. Setup

Press <ENTER> to get in the **MEAS. Setup** option. The **MEAS. Setup** option includes the time delay before measurement and the time continue during the measurement.

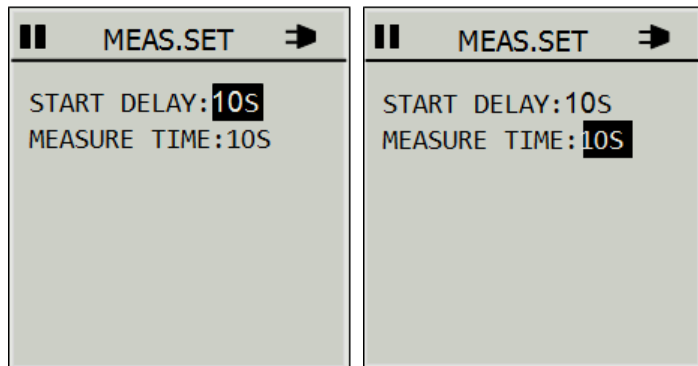

The **START DELAY** defines the delay period from the <START/STOP> pressing to the start of the measurements (the digital filters of the instrument analyses constantly the input signal even when the measurements are stopped). The delay period should be set at 15s or longer when using “SLOW” Detector.

The **MEASURE TIME** defines the period of the measurement at every turn. Press <↑> and <↓> to select the **START DELAY** or **MEASURE TIME**.

START DELAY supply three periods to choose: **3s**, **10s** and **15s**. Please Press <←> and <→> to select the appropriate period of time.

MEASURE TIME supply 6 periods to choose: **10s**, **60s**, **10m**, **1h**, **24h** and infinity. Press <←> and <→> to select the appropriate period of time.

The confirmation of the selection is made by pressing the <ENTER> and it will return **Measurement** automatic. The return without taking into account any change is made after pressing the <ESC>.

4.2.2 MEAS. Range

MEAS. Range provides the range of the **BSWA 308** can measured. Press <ENTER> to enter the **MEAS. Range**. Press <ENTER> or <ESC> to return to the Measurement screen.

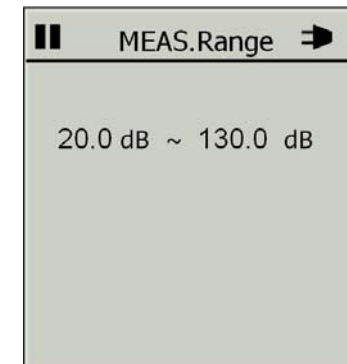

4.2.3 ICCP

ICCP provide the user to enable or disable the ICCP function. If the ICCP function enable, sound level meter can use the ICCP microphone as the input. User can use other transducer when disable the **ICCP**.

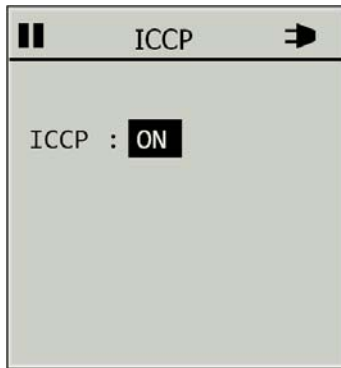

4.2.4 SET1

SET1 enables the user to set the proper parameter of the measurement for first profile which is one of the parallel measurements and display at data-source-name on main screen and first item of 3 profile screens.

In order to enter the window one has to press the <ENTER> on the inversely displayed **SET1** text of the Measurement list.

SET1 option contains 3 alternatives for measurement setup. Press <↑> and <↓> button to select the options.

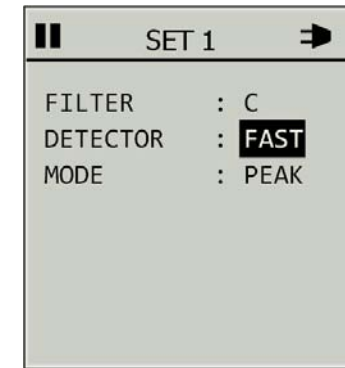

FILTER supply 3 frequency weighting: **A**, **C** and **Z**. Press <←> and <→> to select the appropriate frequency weighting.

DETECTOR supply 3 time weighting: **Fast**, **Slow** and **Imp**. Press <←> and <→> to select the appropriate time weighting.

MODE supply 5 mode of significant results: **SPL**, **RMS**, **PEAK**, **LEQ** and **MAX**. Press <←> and <→> to select the appropriate option.

Press <ENTER> button to save the selection and return the Measurement automatic, press <ESC> to return the Measurement and the select will be lost.

4.2.5 SET2 and SET3

SET2 and **SET3** enables the user to set the proper parameter of the measurement for second profile which is one of the parallel measurements and display at data-source-name on 3 profilescreen.

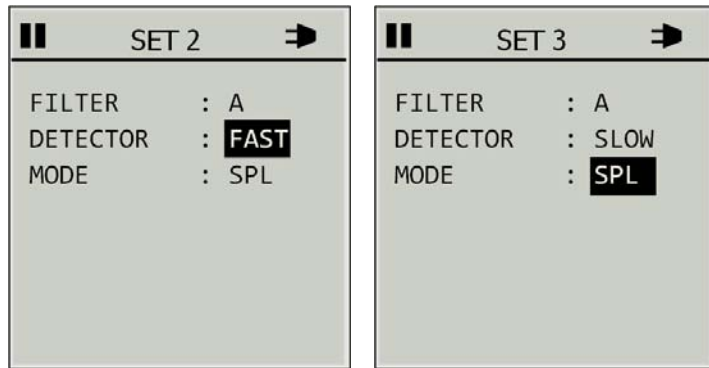

In order to enter the screen, press the <ENTER> on the inversely displayed **SET2** or **SET3** text of the Measurement list.

SET2 and **SET3** option contain 3 alternatives for measurement setup.

Press <↑> and <↓> to select the options.

FILTER supply 3 frequency weighting: **A**, **C** and **Z**. Press <←> and <→> to select the appropriate frequency weighting.

DETECTOR supply 3 time weighting: **Fast**, **Slow** and **Imp**. Press <←> and <→> to select the appropriate time weighting.

MODE supply 5 mode of significant results: **SPL**, **RMS**, **PEAK**, **LEQ** and **MAX**. Press <←> and <→> to select the appropriate option.

Press <ENTER> button to save the selection and return the **Measurement** automatic, press <ESC> to return the **Measurement** and the select will be lost.

4.3 Function

The **Function** option contains **BSWA 308** information, addition function (**Battery**, **Version**) and addition function setup (**Contrast**, **Backlight**,

AutoPwrOff).

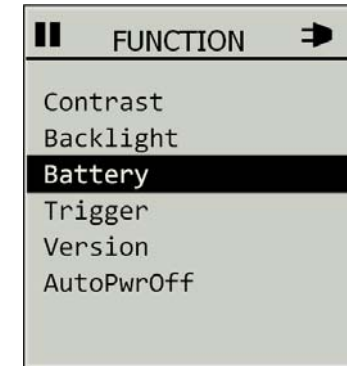

Select the highlighted (displayed inversely) **Function** text in the main menu, press the <ENTER> on the highlighted (displayed inversely) **Function** text to enter the function option.

4.3.1 Contrast

The **Contrast** enables the user to set the proper contrast of the display. The position is opened after pressing the <ENTER> on the highlighted (displayed inversely) **Contrast** text. The user can select 15 different values of this parameter.

Contrast of the LCD will gradual change with pressing <←> and <→>.

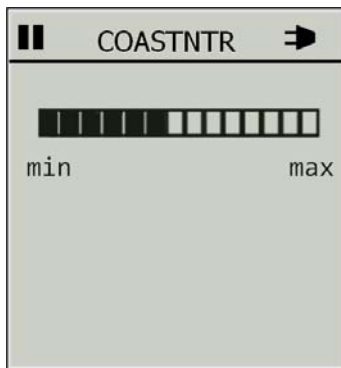

Press <ENTER> to save the selection and return to the **Function** list automatic, press <ESC> to return the **Function** list and the selection will be lost.

4.3.2 Battery

The **Battery** enables the user to check the internal battery condition. In order to enter the screen, press the <ENTER> on the inversely displayed **Battery** text of the **Function** list.

The **Battery** screen is closed and the instrument returns to the **Function** list after pressing the <ESC> or the <ENTER>.

The instrument can be powered from the external power supply, from four AA rechargeable or standard batteries. The view presented on the display for each of 2 kinds of powering sources is different. The current battery voltage is displayed together with its approximate state (in the graphical form).

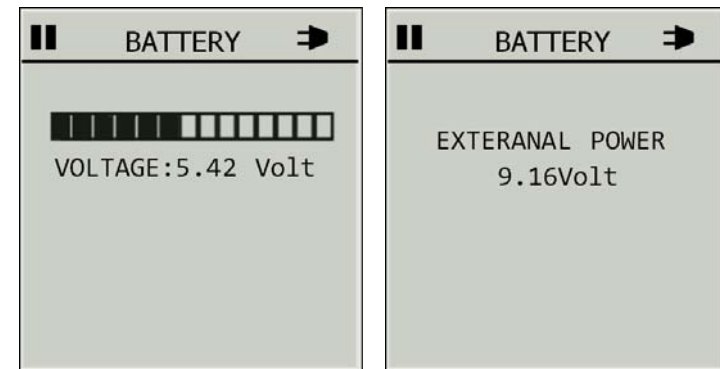

4.3.3 Backlight

Taking into account the saving of the internal source of the instrument's power the backlight should be used relatively rare. It is possible to set the backlight's automatic switch off. In the case when this option is set, after the fixed time which has been set, from pressing the <Backlight> to switch off the backlight.



Timeout provides two modes to choose whether shut down the backlight

automatic, though select **Y** or **N**. Press <←> and <→> to choose automatic switch off or not.

Delay provides the time of the light can continue after the <Backlight> has been pressed if the backlight has been set switch off automatically in the **Timeout** option. There are 6 periods to choose: 10s, 20s, 30s, 40s, 50s, 60s. Press <←> and <→> to choose.

The confirmation of the selection is made by pressing the <ENTER>. The return without taking into account any change is made after pressing the <ESC> button.

4.3.4 Trigger

Trigger is a analog input for control the sound level meter start or stop measurement. BSWA 308 has a 3.5mm socket in the bottom for trigger input. Short the signal and ground of the socket to start measurement, otherwise to stop the measurement. Notice that when enable the Trigger function, the <START/STOP> button on the surface of the sound level meter is disable.

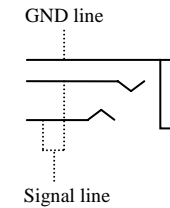

4.3.5 Version

Select the highlighted (displayed inversely) **Version** text in the **Function** menu, press the <ENTER> button on the highlighted (displayed inversely) **Version** text to enter the **Version** option.

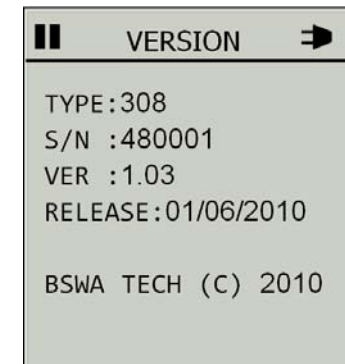

The **Version** item provides the information of instrument. It contains the type and serial number of the instrument, the version and date of the software.

The screen is closed and the instrument returns to the **Function** list after pressing the <ESC> or <ENTER>.

4.3.6 AutoPwrOff

In order to save the internal source of the instrument's power, **BSWA 308** provides the function for automatic shut down the instrument.

This function is only play a part in the state when the instrument is not measuring. The power save mode is disabled in case of a running measurement.



If this option is set, the instrument is switched off after the fixed time which has been set, from pressing any button. If it happened, the pressing of any button would cause the time count restart form zero.

AutoPwrOff provides the time how long the instrument can continue without measurement after the last time of the button has been pressed . There are 5 options to choose: **1m**, **5m**, **10m**, **30m**, **off** (**off** means the time is infinite). Press <←> and <→> to select.

The confirmation of the selection is made by pressing <ENTER>. The

return without taking into account any change is made after pressing <ESC>.

4.4 Language

Select the highlighted (displayed inversely) **Language** text in the main menu , press <ENTER> on the highlighted (displayed inversely) **Language** text to enter the **Language** option.



This option is used to select the language for **BSWA 308** systems, right now the 308 only have English to choose.

The screen is closed and the instrument returns to the **Function** menu after pressing <ESC> or <ENTER>.

4.5 Output

Select the highlighted (displayed inversely) **Output** text in the main menu, press <ENTER> on the highlighted (displayed inversely) **Output** text to enter the **Output** option . This option provides the way for customers used to output the information and data which the **BSWA 308**

has measured.

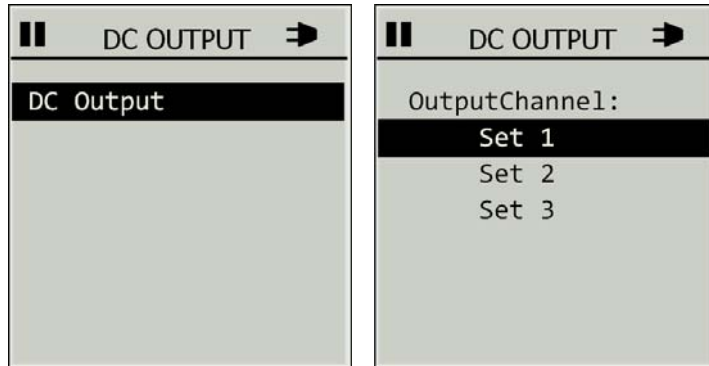

Right now the **BSWA 308** only has **DC Output** to choose, press **<ENTER>** to enter the screen of the **Output**. It has 3 options to choose for output: **SET1, SET2, and SET3**. These options corresponding the 3 profile which have been set in measurement respectively. Press **<↑>** and **<↓>** to select the **Output**, and press **<ENTER>** to save the select and return to the up level menu automatic. Press **<ESC>** will return the up level menu without save.

The data will be outputted from the DC output port.

The screen of **Output** is closed and the instrument returns to the main menu after pressing the **<ESC>** or **<ENTER>**.

4.6 Factory setup

Factory setup provides the function for restore the parameter which has been set by customer, the parameter will be initialized to the original parameter which has been set at factory.

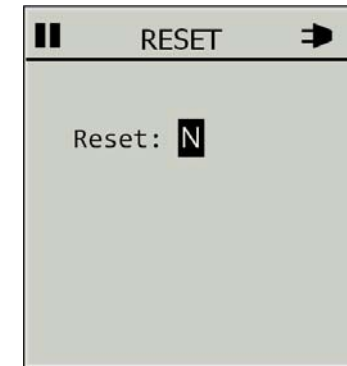

Press **<←>** and **<→>** to choose **Y** (Yes) or **N** (No). Choose **Y** and pressing **<ENTER>** will initialize the parameter. Choose **N** or press **<ESC>** will not effect on the parameter.



BSWA Technology Co., Ltd

Unit 1003, North Ring Center

No.18 Yumin Road, Xicheng District

Beijing 100029, P.R. China

Phone: +86-10-5128 5118

Fax: +86-10-8225 1626

Email: liuwei@bswa.com.cn

Web: www.bswa-tech.com

2010, **BSWA**